

OPERATION – UTILIZAÇÃO – FONCTIONNEMENT – FUNCIONAMIENTO



GMax™ Sprayers

309408 Rev. B

3300 psi (228 bar, 22.8 MPa) Maximum Working Pressure
 Pressão máxima de trabalho de 3300 psi (228 bar, 22.8 MPa)
 Paresion maximale de service 3300 lb/po² (228 bar, 22.8 MPa)
 Presión máxima de operación 3300 psi (228 bar, 22.8 MPa)

GMax 3900
 233700 – 233703

GMax 5900, GMax 5900HD
 233705 – 233708, 233716, 233717

GMax 7900, GMax 7900 Roof Rig
 233718 – 233721, 233740

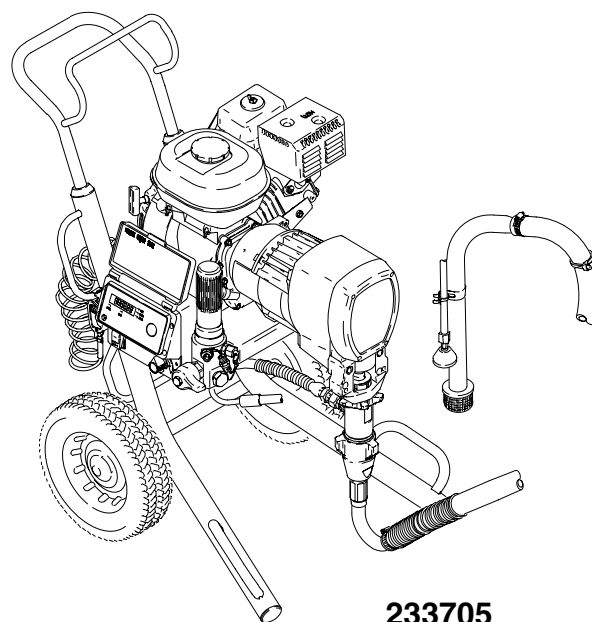

All models not available in all countries.
 Nem todos os modelos existem à disposição em todos os países.
 Tous les modèles ne sont pas disponibles dans tous les pays.
 Hay modelos que no se distribuyen en todos los países.

• Controls	3
• Setup	4
• Startup	6
• Digital Tracking System™ (DTS)	10
• Cleanup	17
• Pressure Relief	17
• Error Codes	21

GRACO INC. P.O. BOX 1441 MINNEAPOLIS, MN 55440-1441

©COPYRIGHT 2002, GRACO INC.

Graco Inc. is registered to I.S. EN ISO 9001



H003

⚠ WARNING

Fire and explosion hazard: Solvent and paint fumes can ignite or explode.

To help prevent a fire and explosion:

- Use only in an extremely well ventilated area.
- Eliminate all ignition sources; such as pilot lights, cigarettes and plastic drop cloths (static arc hazard). Do not plug or unplug power cords or turn lights on or off in spray area.
- Ground Sprayer, object being sprayed, paint and solvent pails.
- Hold gun firmly to side of grounded pail when triggering into pail.
- Use only conductive airless paint hose.
- Do not use 1,1,1-trichloroethane, methylene chloride, other halogenated hydrocarbon solvents or fluids containing such solvents in pressurized aluminum equipment. Such use could result in a chemical reaction, with the possibility of explosion.
- Do not fill fuel tank while engine is running or hot.
- Do not flush with gasoline.

Fluid injection and high pressure hazard: High pressure spray or leaks can inject fluid into the body.

To help prevent injection, always:

- Engage trigger safety latch when not spraying.
- Keep clear of nozzle and leaks.
- Never spray without a tip guard.
- Do **PRESSURE RELIEF** if you stop spraying or begin servicing sprayer.
- Do not use components rated less than sprayer *Maximum Working Pressure*.
- Never allow children to use this unit.

If high pressure fluid pierces your skin, the injury might look like "just a cut". But it is a serious wound! Get immediate medical attention.



⚠ ADVERTÊNCIA

Perigo de incêndio e explosão: os solventes e os vapores da pintura poderão explodir ou incendiar.

Para ajudar a evitar incêndio e explosão:

- Utilize unicamente em áreas extremamente bem ventiladas.
- Elimine todas as fontes de ignição, tais como luzes piloto, cigarros e arcos de estática resultantes dos plásticos de proteção. Não ligue nem desligue os cabos de alimentação ou as luzes numa área de pulverização.
- Ponha em contato com a terra o pulverizador, o objeto a ser pulverizado, e os baldes de tinta e de solventes.
- Segure a pistola firmemente de encontro ao lado do balde em contato com a terra, quando estiver descarregando para dentro do mesmo.
- Utilize somente tubos flexíveis condutores para pintura a alta pressão.
- Não utilize 1,1,1-tricloroetano, cloreto de metileno, outros solventes de hidrocarbonetos halogenados ou líquidos contendo tais solventes em equipamento de alumínio pressurizado. Tal utilização poderá resultar numa reação química, com possibilidade de explosão.
- Nunca abasteça o depósito de combustível com o motor em funcionamento ou quente.
- Não faça a descarga com gasolina.

Perigo de injeção de líquidos à alta pressão: a pulverização ou vazamentos à alta pressão podem injetar líquido no corpo.

Para ajudar a evitar injeção de líquido, faça sempre o seguinte:

- Engate o trinco de segurança do gatilho quando não estiver pulverizando.
- Mantenha-se afastado dos bocais e locais onde há vazamentos.
- Nunca pulverize sem que haja uma proteção na extremidade.
- **ALIVIE A PRESSÃO** quando parar de pulverizar e antes de iniciar a manutenção do pulverizador.
- Não utilize componentes com uma classificação inferior à do pulverizador *Pressão Máxima de Trabalho*.
- Nunca permita que crianças utilizem esta unidade.

Se o líquido a alta pressão penetrar na sua pele, o ferimento poderá parecer "simplesmente um corte". Mas é um ferimento grave! Procure o médico imediatamente.

⚠ MISE EN GARDE

Danger d'incendie et d'explosion : les gaz de solvant et de peinture peuvent s'enflammer ou exploser.

Pour éviter les risques d'incendie et d'explosion :

- N'utiliser l'appareil que dans une zone extrêmement bien aérée.
- Éliminer toute source d'inflammation ; telle que veilleuses, cigarettes et arcs d'électricité statique créés par les toiles de peintre en plastique. Ne pas brancher et débrancher de cordons électriques, ou allumer et éteindre des lumières dans la zone de pulvérisation.
- Mettre à la terre le pulvérisateur, l'objet à pulvériser ainsi que les seaux de peinture et de solvants.
- Tenir le pistolet fermement contre la paroi d'un seau mis à la terre lorsqu'on pulvérise dans le seau.
- N'utiliser qu'un flexible pour peinture pulvérisée sans air.
- Ne jamais utiliser de trichloroéthane 1,1,1, de chlorure de méthylène, d'autres solvants à base d'hydrocarbures halogénés, ni de produits contenant de tels solvants dans un équipement sous pression en aluminium. Cela pourrait provoquer une réaction chimique avec risque d'explosion.
- Ne jamais remplir le réservoir d'essence lorsque le moteur est chaud ou en marche.
- Ne pas rincer avec de l'essence.

Danger d'injection de fluide et haute pression : la pulvérisation sous haute pression ou les fuites peuvent injecter des fluides dans le corps.

Pour éviter les risques d'injection, toujours :

- Bloquer le loquet de sécurité de la gâchette à la fin de la pulvérisation.
- Se tenir loin de la buse et des fuites.
- Ne jamais pulvériser sans anti-gouttes.
- **DÉCHARGER LA PRESSÃO** à la fin de la pulvérisation ou avant de réparer le pulvérisateur.
- Ne pas utiliser de composants dont la pression nominale est inférieure à la *pression maximale de service du système*.
- Ne jamais permettre aux enfants d'utiliser cet appareil.

Si un fluide haute pression perce la peau, la blessure peut paraître une "simple coupure" Mais il s'agit bien d'une lésion grave! Consulter immédiatement un médecin.

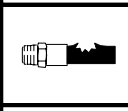

⚠ ADVERTENCIA

Perigo de incendio o explosión: Los gases de los disolventes y de la pintura pueden inflamarse o provocar una explosión.

Para prevenir incendios y explosiones:

- Use únicamente en un área muy bien ventilada.
- Suprima todas las fuentes de ignición; como luces piloto, cigarrillos y arcos estáticos de carpetas plásticas para protección contra pintura. No enchufe ni desenchufe cables de alimentación ni apague ni encienda las luces en un área de pulverización.
- Ponga a tierra el pulverizador, el objeto que recibe el chorro pulverizado, las cubetas de pintura y disolvente.
- Sostenga firmemente la pistola a un lado de la cubeta puesta a tierra cuando dispere dentro de ella.
- Use solamente mangueras para pintura conductora sin aire.
- No utilice nunca tricloroetano-1,1,1, cloruro de metileno ni otros disolventes a base de hidrocarburos halógenos o fluidos que contengan dichos disolventes en un equipo a presión de aluminio. El uso de estas sustancias puede provocar una intensa reacción química, con riesgos de explosión.
- Nunca llene el estanque de combustible mientras el motor esté en marcha o caliente.
- No lave con gasolina.

Perigo de inyección de fluido y alta presión: por la pulverización o las filtraciones a alta presión se pueden inyectar fluidos en el organismo.

Para prevenir la inyección en la piel, siempre:

- Enganche el seguro del gatillo cuando no use el pulverizador.
- No se acerque a la boquilla ni a las filtraciones.
- Nunca aplique fluido pulverizado sin un guardaboquilla.
- Realice el **ALIVIO DE PRESIÓN** si deja de pulverizar fluido o repara el pulverizador.
- No use componentes de capacidad nominal inferior a la *presión máxima de operación del pulverizador*.
- No permita que niños usen esta unidad.

Si fluido de alta presión le penetra la piel, la lesión podría parecer "sólo un corte". ¡Es una lesión seria! Consulte de inmediato al médico.

CONTROLS / CONTROLES / COMMANDES / CONTROLES

On/Off Switch Aan/Uit Schakelaar
 Interrupteur Marche/Arrêt
 Ein-Aus-Schalter

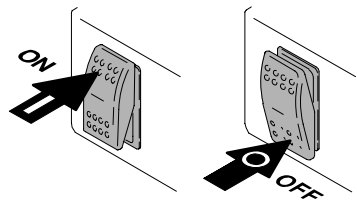

On/Off Switch
 Interruptor de ligar e desligar
 Interrupteur marche/arrêt
 Interruptor de encendido/apagado



Engine Controls
 Controles do motor
 Commandes de moteur
 Controles del motor

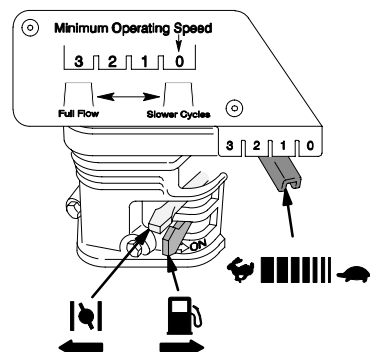

Pressure Control / Controle da pressão /
 Système de contrôle de la pression /
 Dispositivo de control de la presión

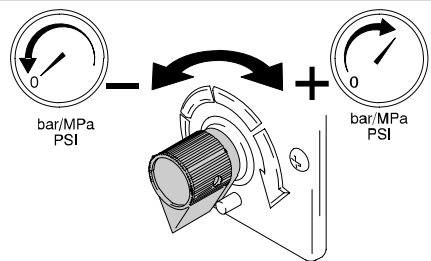

Drain Valve
 Válvula de drenagem
 Vidange
 Válvula de vaciado

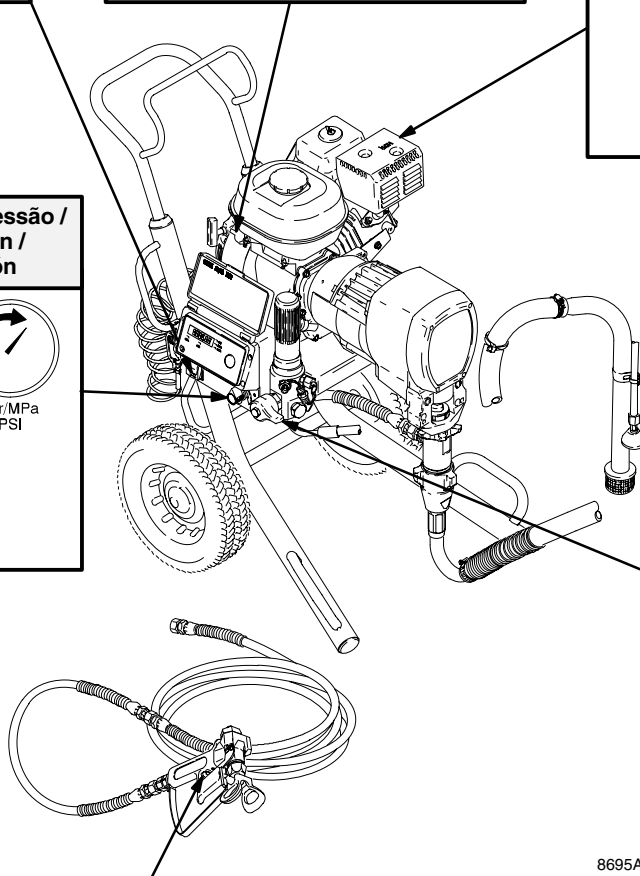
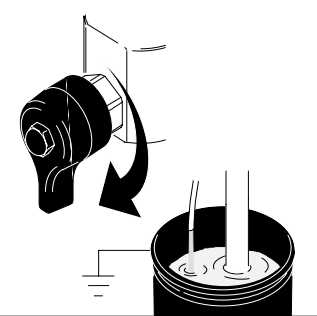
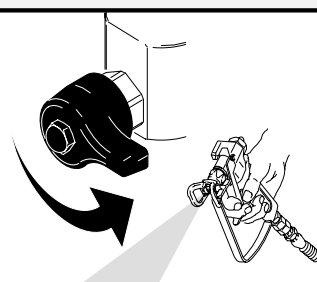

8695A

Trigger Lock
 Fecho do gatilho
 Loquet de sécurité
 Seguro del gatillo

Contractor		Contractor II	
			ti2871a
			ti2870a

Setup

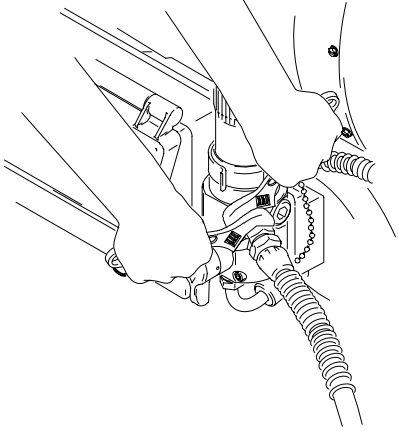

1. Connect appropriate Graco high-pressure hose to sprayer. Tighten securely.



Note: Remove second gun port cap for multiple guns and repeat steps 1 – 4, 7, 8, 10

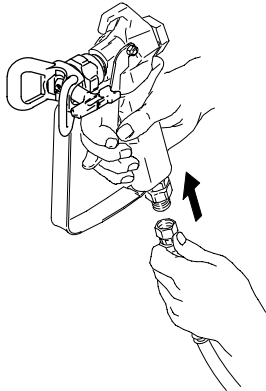

2. Connect other end of hose to gun.

3. Tighten securely.

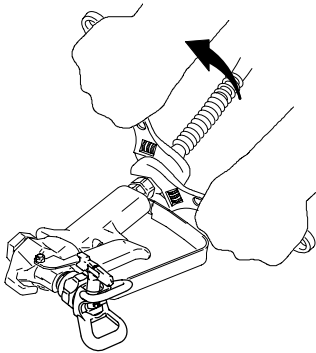

4. Remove tip guard.

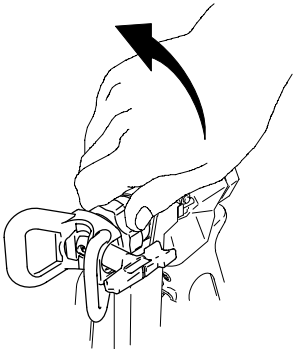

Setup

5. Install clean inlet strainer.

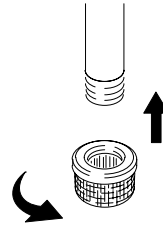

6. Fill throat packing nut with TSL to prevent premature packing wear.
Do this each time you spray and store.

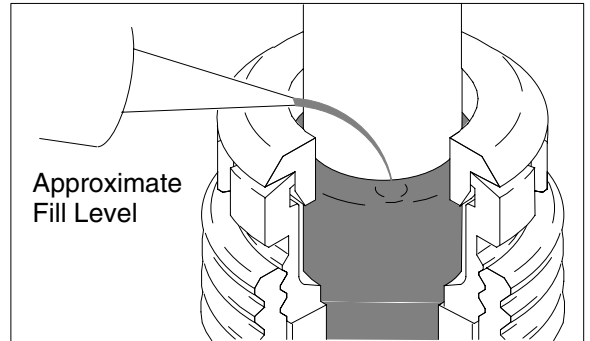

7. Check engine oil level. Add SAE 10W-30 (summer) or 5W-20 (winter), if necessary.

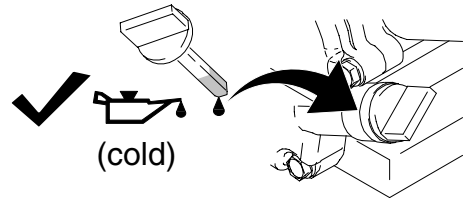

8. Fill fuel tank.

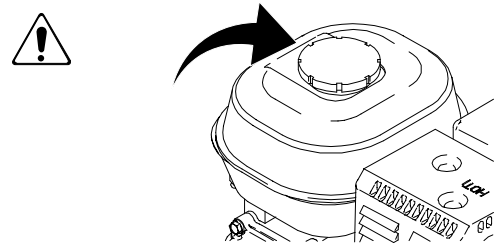

9. Ground sprayer with grounding clamp.

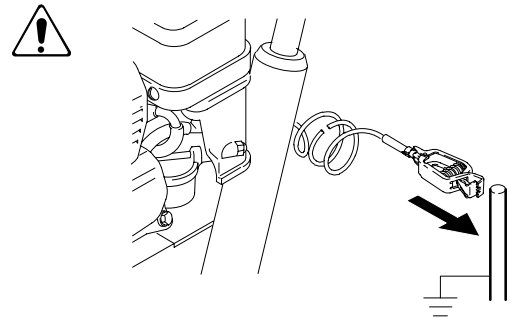

Startup

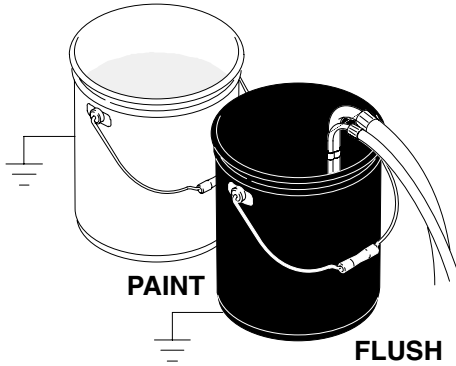

1. Place suction tube and drain tube in grounded metal pail partially filled with flushing fluid. Attach ground wire to pail and to true earth ground.

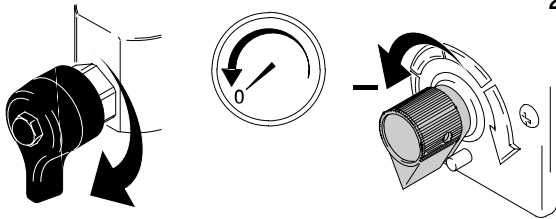

2. Turn prime valve down.
Turn pressure control to lowest pressure.

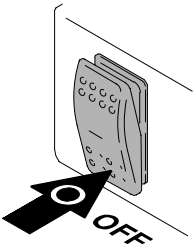

3. Set pump switch OFF.

Startup

4. Start engine

a. Move fuel valve to open



b. Move choke to closed

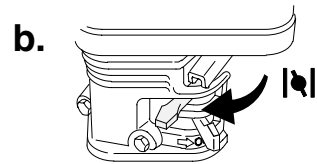

c. Set throttle to fast

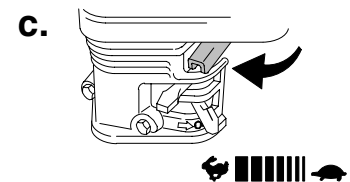

d. Set engine switch ON

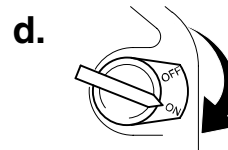

e. Pull starter cord

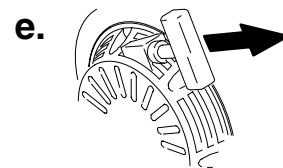

f. After engine starts, move choke to open

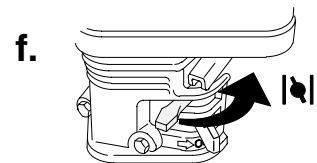

g. Set throttle to desired setting

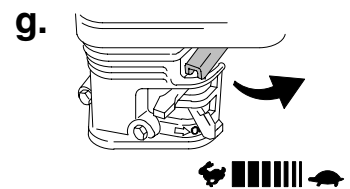

– Digital display is functional after engine starts –

Startup

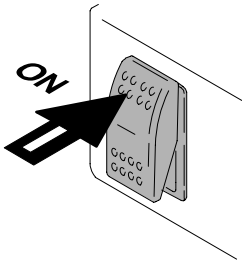

5. Set pump switch ON.
– Pump/clutch is now active –

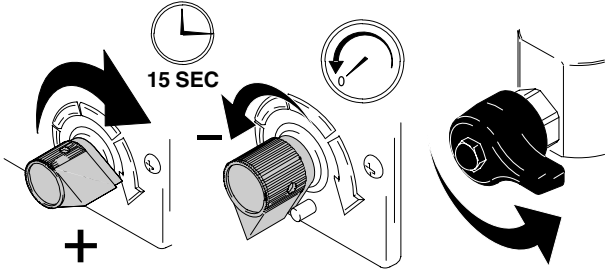

6. Increase pressure enough to start pump stroking and allow fluid to circulate for 15 seconds; turn pressure down, turn prime valve horizontal.

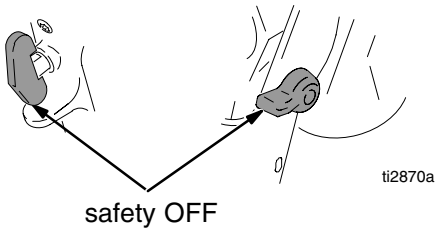

7. Take spray gun trigger safety OFF.

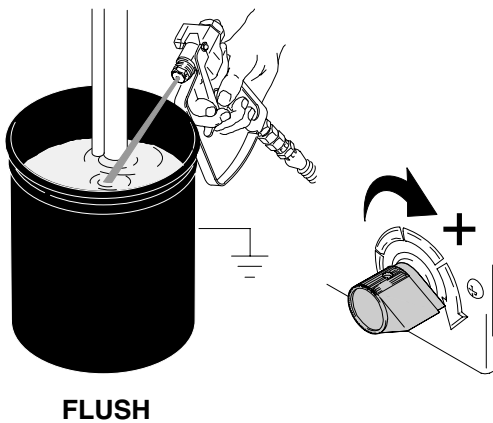

8. Hold gun against grounded metal flushing pail. Trigger gun and increase fluid pressure slowly until pump runs smoothly.

Note: Inspect fittings for leaks.   **Do not stop leaks with your hand or a rag!** If leaks occur, turn sprayer OFF immediately. Do **Pressure Relief** in **Cleanup, 1. – 3.** on page 17. Tighten leaky fittings. Repeat **Startup, 1. – 5.** If no leaks, continue to trigger gun until system is thoroughly flushed. Proceed to **6.**

Startup

9. Place siphon tube in paint pail.

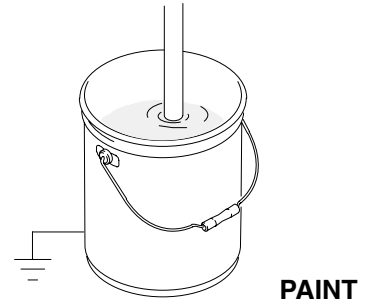

10. Trigger gun again into flushing fluid pail until paint appears. Assemble tip and guard, page 9.

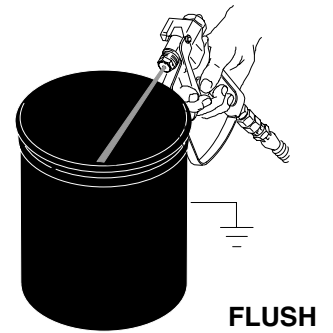

SwitchTip and Guard Assembly

1. Engage trigger safety.

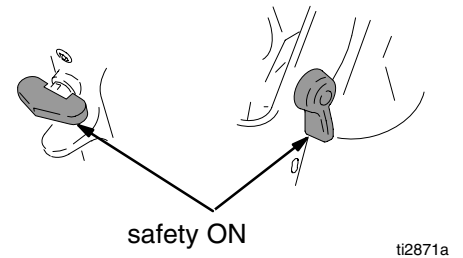

2. Insert SwitchTip™.
Insert seat and OneSeal™.

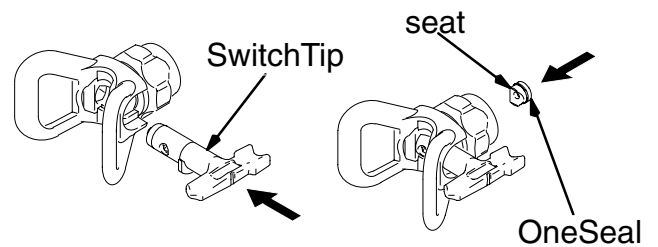

3. Screw assembly onto gun. Hand tighten.

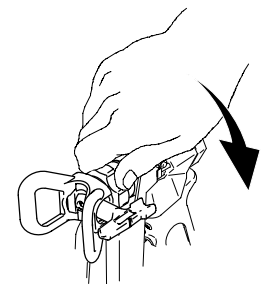

Operation



Close cover when spraying
to protect from overspray

Main Menu

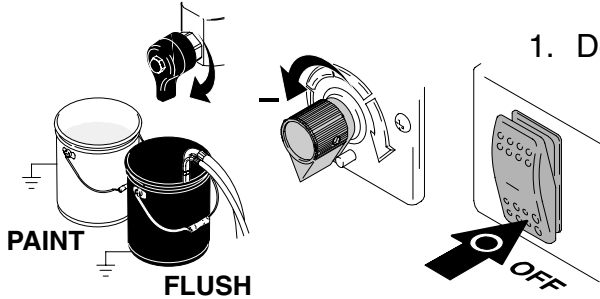

1. Do **Startup** steps 1. – 3.

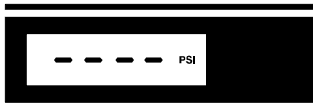

2. Start engine, page 7.

Sprayer Model momentarily displays, e. g., G5900 = GMax 5900

Pressure display appears. Dashes appear when pressure is less than 200 psi (14 bar, 1.4 MPa).

Note: Information other than pressure can not be accessed if system pressure is greater than 200 psi (14 bar, 1.4 MPa). or if the pump switch is ON.

Digital Tracking System (DTS)

3. Short press DTS button to move to Job Gallons (or Liters x 10).

Note: JOB displays briefly, then the number of gallons sprayed above 1000 psi (70 bar, 7 MPa).

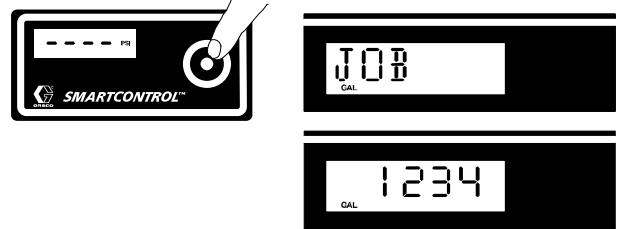

4. Press and hold to reset to zero, or short press DTS button to move to Lifetime Gallons (or Liters x 10).

Note: LIFE displays briefly, then the number of gallons sprayed above 1000 psi (70 bar, 7 MPa).

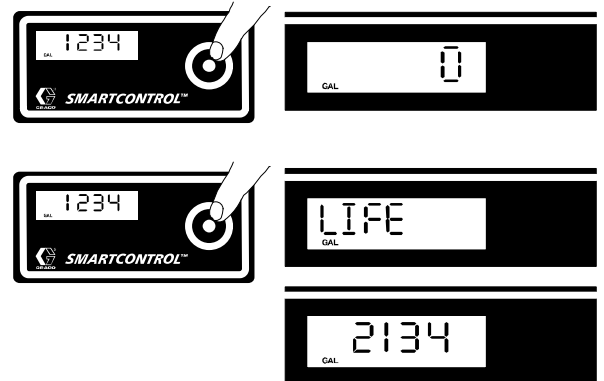

5. Short press DTS button to move to Auto-Clean Timer operation (Manual 309278).

Note: If the pump is started in the timer mode, the timer counts down to zero and shuts the pump OFF. Use for flushing only.



6. Short press DTS button to return to Pressure.



WatchDog™ Pump Protection System

Pump stops automatically when material pail is empty.

To Activate:

1. Do **Startup**.

Increase pressure to more than 2000 psi (140 bar, 14 MPa).

Note: Instructions to automatically activate the WatchDog pump protection system every time you spray are on page 14.



2. Press and hold DTS button, release when ON is displayed.



Note: GAL (or LITER) flashes while pump protection system is active.



EMPTY displays and the pump stops when pump protection system detects an empty material pail.

3. Turn pump switch OFF to resume normal operation.

Change Display Units:



Pressure:

Press and hold (5 seconds) DTS button to change pressure units (psi, bar, MPa), to desired units.



Volume:

Press and hold (5 seconds) DTS button to change volume units (GAL, LITERX10).

Secondary Menu – Stored Data and WatchDog Pump Protection Modes

1. Do **Startup** steps 1. – 3.
Pressure must be at zero.

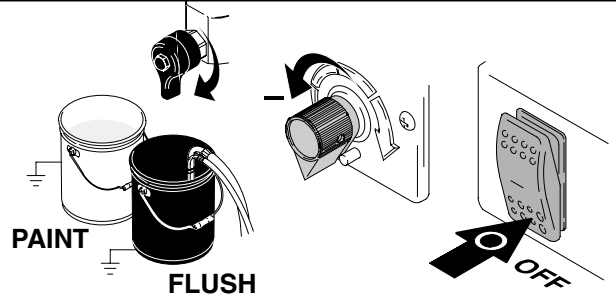

2. Start engine, page 7.
Pressure display appears.

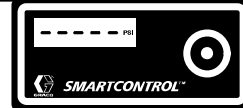

3. Simultaneously press DTS button and set pump on/off switch on.
Sprayer model momentarily displays,
e.g., G5900 = GMAX 5900.

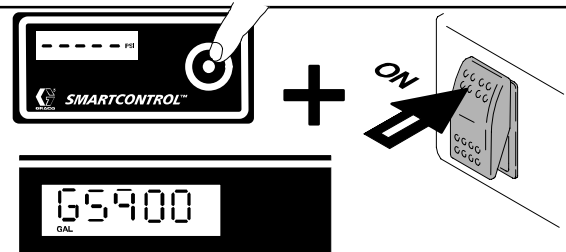

Resettable Hour Meter appears.

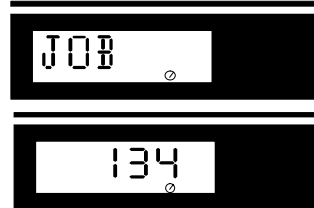

Secondary Menu – Stored Data and WatchDog Pump Protection Modes



4. Press and hold to reset to zero, or



5. Short press DTS button to move to Lifetime Hour Meter.

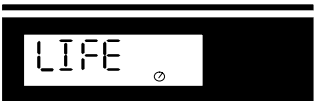

6. Short press DTS button to move to TOTAL Gallons (all pressures).

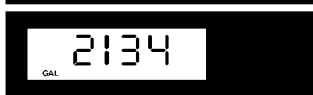

7. Press DTS button to move to stored error code. Press and hold DTS button to clear error code to E=00. See Manual 309409.



8. Short press DTS button to move to WatchDog pump protection options menu.



Secondary Menu – Stored Data and WatchDog Pump Protection Modes

9. Short press DTS button again to move to WatchDog MAN (manual) mode.



10. Press and hold to switch between MAN (standard) and AUTO mode. In AUTO mode, WatchDog pump protection is active once pressure is over 1500 psi (103 Bar, 10.3 MPa)

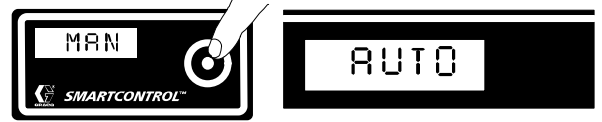

-
11. Short press to return to step 3.

-
12. Turn pump switch OFF at any time to exit stored data mode.

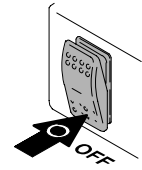

Spray Test Pattern

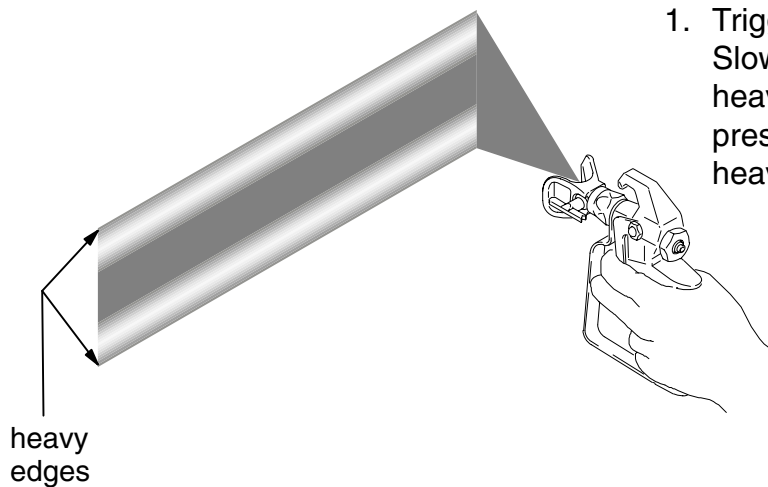

1. Trigger gun and spray test pattern. Slowly adjust pressure to eliminate heavy edges. Use smaller tip size if pressure adjustment can not eliminate heavy edges.

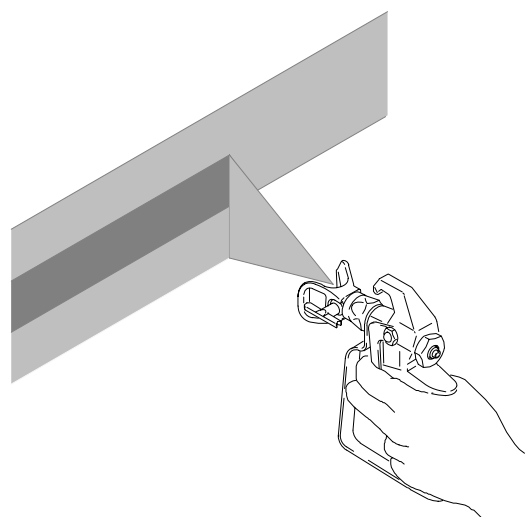

2. Hold gun perpendicular, 10–12 in. (25–30 cm) from surface. Spray back and forth. Use strokes overlapped by 50%. Start gun movement before triggering gun and release trigger before stopping gun movement.

Clearing Tip Clogs

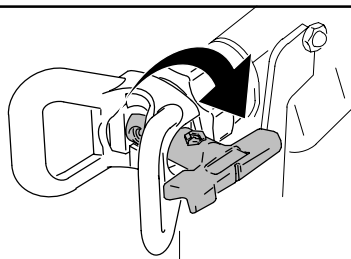

1. Release trigger, put trigger safety ON. Rotate SwitchTip. Take trigger safety OFF and trigger gun to clear the clog.

⚠ Never point gun towards your hand or into a rag!

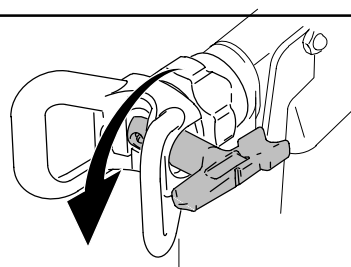

2. Put trigger safety ON, return SwitchTip to original position, take trigger safety OFF and continue spraying.

Cleanup

Perform **AutoClean procedure (Manual 309278)** or follow conventional flushing procedure that follows:



Pressure Relief

1. Set pump switch OFF.
Turn engine **OFF**.

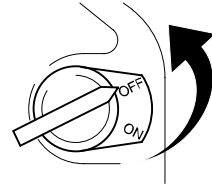
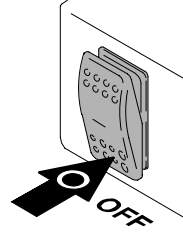

Pressure Relief

2. Turn pressure to lowest setting.
Trigger gun to relieve pressure.

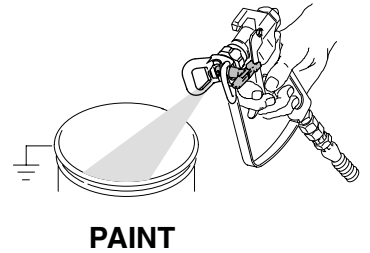
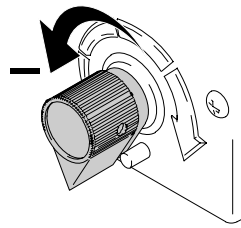

Pressure Relief

3. Turn prime valve down.

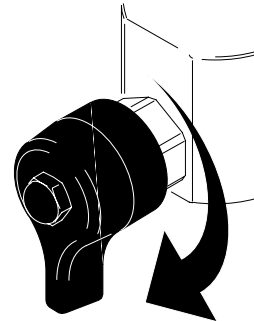

4. Remove guard and SwitchTip.

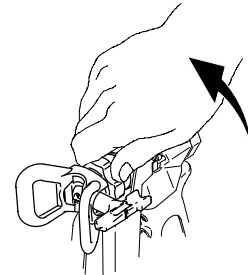

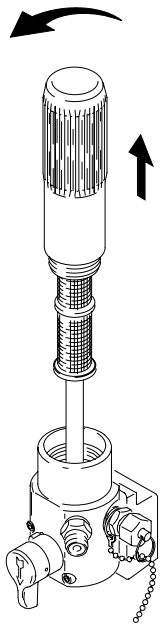

5. Unscrew bowl, remove filter. Assemble without filter. Clean filter.

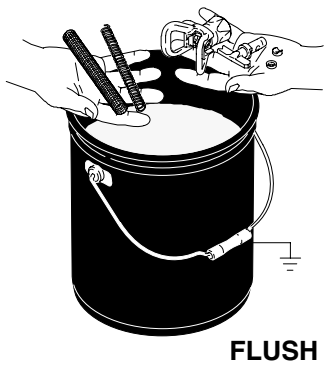

6. Clean filter, guard and SwitchTip in flushing fluid.

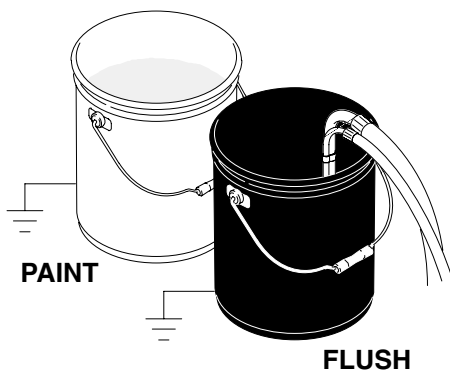

7. Remove siphon tube set from paint and place in flushing fluid. Use water for water base paint and mineral spirits for oil base paint.

-
8. Turn engine **ON** and start engine.
Set pump switch **ON**.

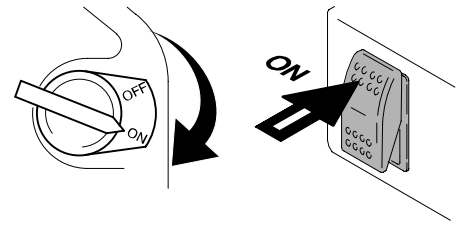

-
9. Turn prime valve horizontal.

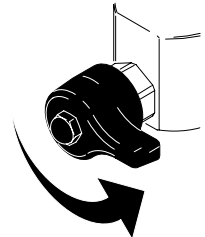

-
10. Hold gun against paint pail. Take trigger safety **OFF**. Trigger gun until flushing fluid appears.
Turn pressure control up until motor begins to drive pump.

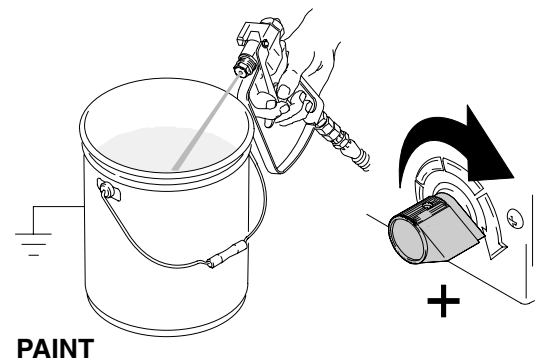

-
11. Move gun to flushing pail, hold gun against pail, trigger gun to thoroughly flush system.

Release trigger and put trigger safety **ON**.

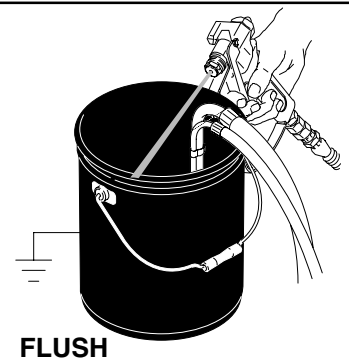

-
12. Turn prime valve down and allow flushing fluid to circulate for approximately 20 seconds to clean drain tube.

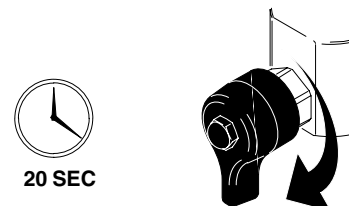

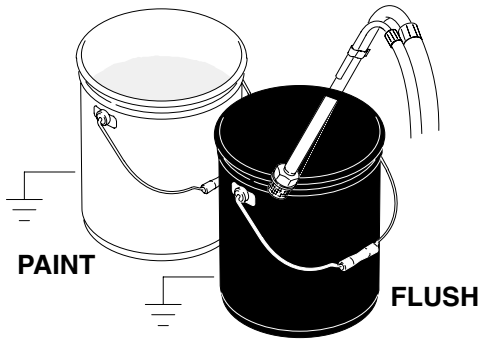

13. Raise siphon tube above flushing fluid and run sprayer for 15 to 30 seconds to drain fluid. Turn pump switch OFF. Turn engine **OFF**.

Caution: If flushing with water, do not leave water in sprayer. Flush again with mineral spirits, oil or Pump Armor and leave this protective coating in the sprayer to help prevent freezing or corrosion and increase sprayer life.

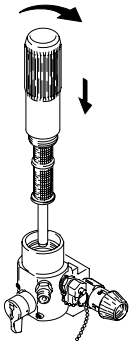

14. Make sure plastic center tube is tightened securely. Install filter bowl and filter. Hand tighten filter bowl. Hand tighten gun handle.



15. Wipe sprayer, hose and gun with a rag soaked in water or mineral spirits.

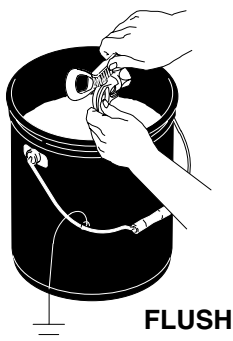

16. Clean tip, guard and gasket with a soft bristle brush to prevent part failure due to dried materials. Assemble parts and attach loosely onto gun.

DTS Error Codes

E:02

E:03

E:07

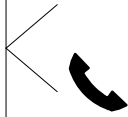

Service

Reference Repair Manual 309409 or 309411 or call your distributor for service

Graco Warranty

Graco warrants all equipment listed in this manual which is manufactured by Graco and bearing its name to be free from defects in material and workmanship on the date of sale by an authorized Graco distributor to the original purchaser for use. With the exception of any special extended or limited warranty published by Graco, Graco will, for a period of twelve months from the date of sale, repair or replace any part of the equipment determined by Graco to be defective. This warranty applies only when the equipment is installed, operated and maintained in accordance with Graco's written recommendations.

This warranty does not cover, and Graco shall not be liable for general wear and tear, or any malfunction, damage or wear caused by faulty installation, misapplication, abrasion, corrosion, inadequate or improper maintenance, negligence, accident, tampering, or substitution of non-Graco component parts. Nor shall Graco be liable for malfunction, damage or wear caused by the incompatibility of Graco equipment with structures, accessories, equipment or materials not supplied by Graco, or the improper design, manufacture, installation, operation or maintenance of structures, accessories, equipment or materials not supplied by Graco.

This warranty is conditioned upon the prepaid return of the equipment claimed to be defective to an authorized Graco distributor for verification of the claimed defect. If the claimed defect is verified, Graco will repair or replace free of charge any defective parts. The equipment will be returned to the original purchaser transportation prepaid. If inspection of the equipment does not disclose any defect in material or workmanship, repairs will be made at a reasonable charge, which charges may include the costs of parts, labor, and transportation.

Graco's sole obligation and buyer's sole remedy for any breach of warranty shall be as set forth above. The buyer agrees that no other remedy (including, but not limited to, incidental or consequential damages for lost profits, lost sales, injury to person or property, or any other incidental or consequential loss) shall be available. Any action for breach of warranty must be brought within two (2) years of the date of sale.

GRACO MAKES NO WARRANTY, AND DISCLAIMS ALL IMPLIED WARRANTIES OF MERCHANTABILITY AND FITNESS FOR A PARTICULAR PURPOSE IN CONNECTION WITH ACCESSORIES, EQUIPMENT, MATERIALS OR COMPONENTS SOLD BUT NOT MANUFACTURED BY GRACO. These items sold, but not manufactured by Graco (such as electric motors, gas engines, switches, hose, etc.), are subject to the warranty, if any, of their manufacturer. Graco will provide purchaser with reasonable assistance in making any claim for breach of these warranties.

In no event will Graco be liable for indirect, incidental, special or consequential damages resulting from Graco supplying equipment hereunder, or the furnishing, performance, or use of any products or other goods sold hereto, whether due to a breach of contract, breach of warranty, the negligence of Graco, or otherwise.

FOR GRACO CANADA CUSTOMERS

The parties acknowledge that they have required that the present document, as well as all documents, notices and legal proceedings entered into, given or instituted pursuant hereto or relating directly or indirectly hereto, be drawn up in English. Les parties reconnaissent avoir convenu que la rédaction du présente document sera en Anglais, ainsi que tous documents, avis et procédures judiciaires exécutés, donnés ou intentés à la suite de ou en rapport, directement ou indirectement, avec les procédures concernées.

ADDITIONAL WARRANTY COVERAGE

Graco does provide extended warranty and wear warranty for products described in the "Graco Contractor Equipment Warranty Program".

Graco Phone Number

TO PLACE AN ORDER, contact your Graco distributor, or call this number to identify the distributor closest to you:
1-800-690-2894 Toll Free.

*All written and visual data contained in this document reflects the latest product information available at the time of publication.
Graco reserves the right to make changes at any time without notice.*

Sales Offices: Minneapolis, Detroit
International Offices: Belgium, Korea, Hong Kong, Japan

GRACO INC. P.O. BOX 1441 MINNEAPOLIS, MN 55440-1441

<http://www.graco.com>

PRINTED IN U.S.A. 309408 3/2003